

## FLAT SURFACE

### D12047

PROJECT \_\_\_\_\_

TYPE \_\_\_\_\_

NOTES \_\_\_\_\_

QUANTITY \_\_\_\_\_

DATE \_\_\_\_\_

#### GENERAL

Series: Flat

Division: Design

Mounting Type: Surface

Mounting Location: Wall

Subcategory: Ambient

#### PHYSICAL

Shape: Square

Length (mm): 152

Length (in): 6.0

Width (mm): 152

Width (in): 6.0

Height (mm): 76

Height (in): 3.0

Extension (mm): 76

Extension (in): 3.0

Light Distribution: Direct

Weight (lbs): 2

Diffuser: Opal White Satin Acrylic

Fixture Finish: Chrome

Fixture Material: Metal

#### ELECTRICAL

Number of Lamps: 1

Lamp Type: CFL

Bulb Included: Bulb Not Included

Total Output Wattage (W): 13

Max. Wattage Per Lamp (W): 13

Lamp Base: GX23-2

Dimming: Non-Dimmable

Driver Included: Yes

Driver Location: Integrated

Driver Type: Ballast - Universal

Input Voltage (V): 120 - 277

#### LED

#### OPTICAL

#### RATINGS AND CERTIFICATIONS

Certified By: CSA Certified to UL and CSA Standards

IP rating: IP20

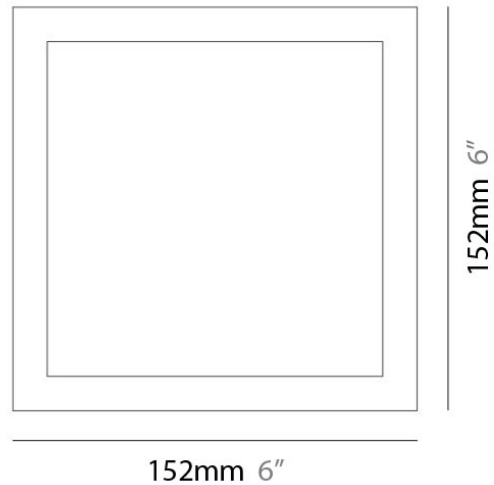

## FLAT SURFACE

### D12048

PROJECT	_____
TYPE	_____
NOTES	_____
QUANTITY	_____
DATE	_____

#### GENERAL

Series: Flat  
Division: Design  
Mounting Type: Surface  
Mounting Location: Ceiling  
Subcategory: Ambient

#### PHYSICAL

Shape: Square  
Length (mm): 298  
Length (in): 11 3/4  
Width (mm): 298  
Width (in): 11 3/4  
Height (mm): 80  
Height (in): 3 1/8  
Extension (mm): 80  
Extension (in): 3 1/8  
Light Distribution: Direct  
Weight (kg): 2.26  
Weight (lbs): 5  
Diffuser: Opal White Satin Acrylic  
Fixture Finish: WHI  
Fixture Material: Metal

#### ELECTRICAL

Number of Lamps: 2  
Lamp Type: LED Retrofit / CFL  
Bulb Included: Bulb Not Included  
Total Output Wattage (W): 20 / 36  
Max. Wattage Per Lamp (W): 10 / 18  
Lamp Base: 2G11  
Driver Included: Yes  
Driver Location: Integrated  
Driver Type: Ballast - Universal  
Input Voltage (V): 120 - 277  
Lamp Voltage (V): 120

#### LED

#### OPTICAL

#### RATINGS AND CERTIFICATIONS

Certified By: CSA Certified to UL and CSA Standards  
IP rating: IP20



298mm 11 3/4"



PROJECT	_____
TYPE	_____
NOTES	_____
QUANTITY	_____
DATE	_____

## FLAT SURFACE

### D12050

#### GENERAL

Series: Flat  
Division: Design  
Mounting Type: Surface  
Mounting Location: Ceiling  
Subcategory: Ambient

#### PHYSICAL

Shape: Square  
Length (mm): 298  
Length (in): 11 3/4  
Width (mm): 298  
Width (in): 11 3/4  
Height (mm): 80  
Height (in): 3 1/8  
Extension (mm): 80  
Extension (in): 3 1/8  
Light Distribution: Direct  
Weight (kg): 2.26  
Weight (lbs): 5  
Diffuser: Opal White Satin Acrylic  
Fixture Finish: Chrome  
Fixture Material: Metal

#### ELECTRICAL

Number of Lamps: 2  
Lamp Type: LED Retrofit / CFL  
Bulb Included: Bulb Not Included  
Total Output Wattage (W): 26 / 36  
Max. Wattage Per Lamp (W): 13 / 18  
Lamp Base: 2G11  
Driver Included: Yes  
Driver Location: Integrated  
Driver Type: Ballast - Universal  
Input Voltage (V): 120 - 277  
Lamp Voltage (V): 120

#### LED

#### OPTICAL

#### RATINGS AND CERTIFICATIONS

Certified By: CSA Certified to UL and CSA Standards  
IP rating: IP20

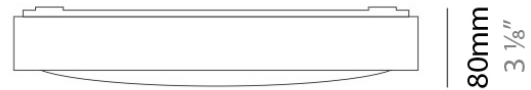

298mm 11 3/4"



## FLAT SURFACE

### D12060

PROJECT	_____
TYPE	_____
NOTES	_____
QUANTITY	_____
DATE	_____

#### GENERAL

Series: Flat  
Division: Design  
Mounting Type: Surface  
Mounting Location: Ceiling  
Subcategory: Ambient

#### PHYSICAL

Shape: Rectangle  
Length (mm): 597  
Length (in): 23 1/2  
Width (mm): 222  
Width (in): 8 3/4  
Height (mm): 83  
Height (in): 3 1/4  
Extension (mm): 83  
Extension (in): 3 1/4  
Light Distribution: Direct  
Weight (kg): 2.73  
Weight (lbs): 6  
Diffuser: Opal White Satin Acrylic  
Fixture Finish: WHI  
Fixture Material: Aluminum

#### ELECTRICAL

Number of Lamps: 2  
Lamp Type: T5 Fluorescent  
Bulb Included: Bulb Not Included  
Total Output Wattage (W): 48  
Max. Wattage Per Lamp (W): 24  
Lamp Base: G5  
Dimming: Phase Dimming (120Vac Only)  
Driver Included: Yes  
Driver Location: Integrated  
Driver Type: Ballast - Universal  
Input Voltage (V): 120 - 277  
Upon Request: (Not included - see components) Integral: Phase dimming / Lutron

#### LED

#### OPTICAL

#### RATINGS AND CERTIFICATIONS

Certified By: CSA Certified to UL and CSA Standards  
IP rating: IP20

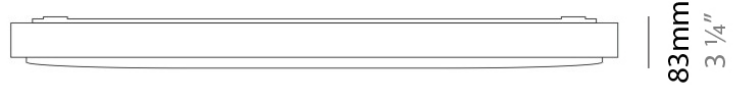

597mm 23 1/2"



## FLAT SURFACE

### D12061

#### GENERAL

Series: Flat  
Division: Design  
Mounting Type: Surface  
Mounting Location: Ceiling  
Subcategory: Ambient

#### PHYSICAL

Shape: Rectangle  
Length (mm): 597  
Length (in): 23 1/2  
Width (mm): 222  
Width (in): 8 3/4  
Height (mm): 83  
Height (in): 3 1/4  
Extension (mm): 83  
Extension (in): 3 1/4  
Weight (kg): 2.73  
Weight (lbs): 6  
Diffuser: Opal White Satin Acrylic  
Fixture Finish: NIC  
Fixture Material: Metal

#### ELECTRICAL

Number of Lamps: 2  
Lamp Type: T5 Fluorescent  
Bulb Included: Bulb Not Included  
Total Output Wattage (W): 48  
Max. Wattage Per Lamp (W): 24  
Lamp Base: G5  
Dimming: Phase Dimming (120Vac Only)  
Driver Included: Yes  
Driver Location: Integrated  
Driver Type: Ballast - Universal  
Input Voltage (V): 120 - 277  
Upon Request: (Not included - see components) Integral: Phase dimming / Lutron

#### LED

#### OPTICAL

#### RATINGS AND CERTIFICATIONS

Certified By: CSA Certified to UL and CSA Standards  
IP rating: IP20

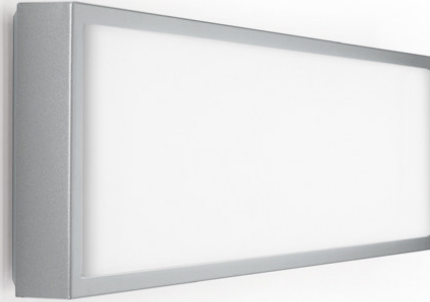

83mm  
3 1/4"

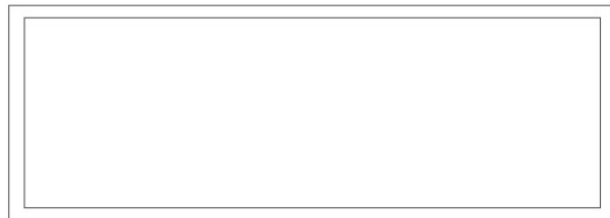

222mm  
8 3/4"

597mm 23 1/2"



PROJECT	
TYPE	
NOTES	
QUANTITY	
DATE	

## FLAT SUSPENSION

### D81429-WHI

#### GENERAL

Series: Flat  
 Brand: Panzeri  
 Division: Design  
 Mounting Type: Suspension  
 Mounting Location: Ceiling  
 Subcategory: Ambient

#### PHYSICAL

Shape: Square  
 Length (mm): 510  
 Length (in): 20 <sup>1</sup>/<sub>16</sub>"  
 Width (mm): 510  
 Width (in): 20 <sup>1</sup>/<sub>16</sub>"  
 Height (mm): 45  
 Height (in): 1 <sup>3</sup>/<sub>4</sub>"  
 Max. Overall Height (mm): 2510  
 Max. Overall Height (in): 98 <sup>13</sup>/<sub>16</sub>"  
 Light Distribution: Direct / Indirect  
 Weight (kg): 7.21  
 Weight (lbs): 15.89  
 Diffuser: White Blown Glass  
 Fixture Material: Metal

#### ELECTRICAL

Lamp Type: LED  
 Input Wattage (W): 61  
 Total Output Wattage (W): 57.5  
 Max. Wattage Per Lamp (W): 46 / 11.5  
 Dimming: Tri-Mode (Non-Dimming and Phase Dimming (120Vac only) and 0-10V Dimming)  
 Driver Included: Yes  
 Driver Location: Integrated  
 Driver Type: Constant Current - Universal  
 Driver Class: Class 2  
 Input Voltage (V): 120 - 277  
 Constant Current (MA): 700

#### LED

Color Temperature (°K): 3000  
 Max. Delivered Lumen (lm): 4077  
 Nominal Lumen (lm): 4800lm down+1200lm up  
 CRI: >80 CRI  
 Lamp Life (hrs): 60000

#### OPTICAL

#### RATINGS AND CERTIFICATIONS

Certified By: CSA Certified to UL and CSA Standards  
 IP rating: IP40



PROJECT	_____
TYPE	_____
NOTES	_____
QUANTITY	_____
DATE	_____

## FLAT SURFACE

### D82230-WHI

#### GENERAL

Series: Flat  
Brand: Panzeri  
Division: Design  
Mounting Type: Surface  
Mounting Location: Ceiling  
Subcategory: Ambient

#### PHYSICAL

Shape: Square  
Length (mm): 510  
Length (in): 20 1/16  
Width (mm): 510  
Width (in): 20 1/16  
Height (mm): 45  
Height (in): 1 3/4  
Light Distribution: Direct / Indirect  
Weight (kg): 5.236  
Weight (lbs): 11.54  
Diffuser: Polycarbonate - Opal  
Fixture Material: Metal

#### ELECTRICAL

Input Wattage Range: 30 - 49 W  
Lamp Type: LED  
Input Wattage (W): 48  
Total Output Wattage (W): 46  
Dimming: Non-Dimming / Phase Dimming (120Vac only) / 0-10V Dimming  
Driver Included: Yes  
Driver Location: Integrated  
Driver Type: Constant Current - Universal  
Driver Class: Class 2  
Input Voltage (V): 120 - 277  
Constant Current (mA): 350

#### LED

Color Temperature (°K): 3000  
Max. Delivered Lumen (lm): 3202  
Nominal Lumen (lm): 5700  
CRI: >80 CRI  
Efficiency (%): 56.175%  
Lamp Life (hrs): 70000

#### OPTICAL

#### RATINGS AND CERTIFICATIONS

Certified By: CSA Certified to UL and CSA Standards  
IP rating: IP40

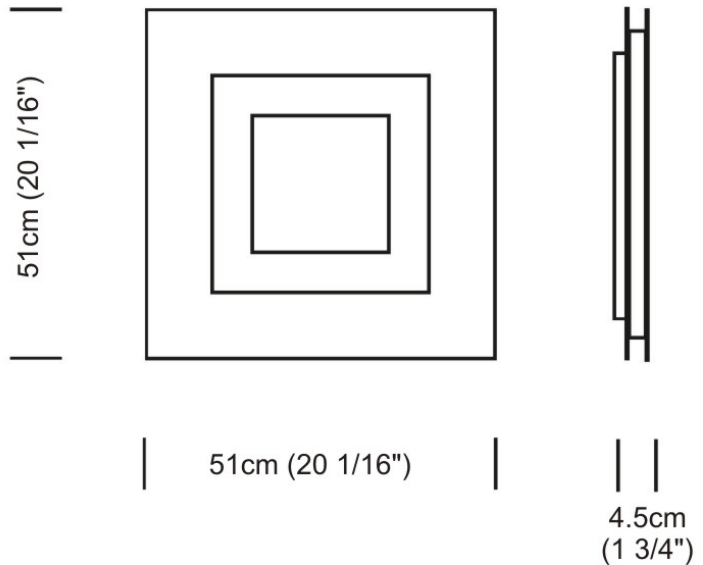











## LEGEND

	floor-mounted		pivotal		special LED (upon request) RGB, RGBW, tunable, gold+, meat+, art+, fashion+
	wall and ceiling: recessed and surface mounted		rotating		warm dim / natural dimming LED
	ceiling-mounted and wall-mounted		illuminate tilted		rechargeable battery powered
	wall-mounted		color of suspension cable		fixture with natural vivid LED (upon request)
	omni-directional light distribution		length of suspension cable		color rendering index
	direct light distribution		reflector degree selection		color temperature
	direct/indirect light distribution		super spot		lumen (luminous flux)
	indirect light distribution		lens		efficacy (lumens per watt)
	asymmetric light distribution		lens pack		Unified Glare Rating (UGR) range from 5-40
	aura light distribution		shine ring		marine grade (AISI 316 stainless steel)
	round wall or ceiling cut-out		integrated shine ring with diffuser		walk on
	square wall or ceiling cut-out		free individual colors 01-29		drive on
	the supplied jig specifies the cutout dimensions		individual colors: 00 (free of charge), 01-25 (extra charge)		Dark Sky Compliance
	minimum distance (meters) lamp - object		luminaire part to be colored (F1)		Americans with Disabilities Act (less than 4" off the wall located between 27"-84" from floor)
	recessed depth		luminaire part to be colored (F2)		lamp protected against explosion
	ceiling thickness in mm		luminaire part to be colored (F3)		blown glass using traditional methods by master glass blower
	ceiling thickness selection		luminaire part to be colored (F4)		acoustic material
	dimmable DP (phase), DV (0-10V), DD (dali), DS (step-dim)		luminaire part to be colored (F5)		protection class I, protection insulation
	included or excluded LED driver/transformer/control gear		color of 3-circuit adaptor		protection class II, protection insulation
	separately switchable		indirect diffuser		ETL Certified to UL and CSA Standards
	sensor		direct diffuser		UL Certified to UL and CSA Standards
	remote control		ball-proof (upon request)		CSA Certified to UL and CSA Standards
	available upon request		accessory		Certified for North American Standards

## IP RATING

	protected against ingress of solid bodies greater than 12.5mm (finger)
	protected against ingress of solid bodies greater than 2.5mm protected against sprays of water up to 60 degrees from the vertical (rain)
	protected against ingress of solid bodies greater than 1mm (wire) no protection against the ingress of moisture
	protected against ingress of solid bodies greater than 1mm (wire) protected against sprays of water up to 60 degrees from the vertical (rain)
	protected against ingress of solid bodies greater than 1mm (wire) protected against water splashed from all directions
	protected against limited ingress of dust (wet rooms/covered outdoor areas) protected against water splashed from all directions
	protected against ingress of dust protected against jets of water
	protected against ingress of dust protected against powerful jets of water or heavy seas
	protected against ingress of dust protected against immersion of water between 15cm - 1m for 30 minutes
	protected against ingress of dust protected against immersion of water under pressure for long periods

## IK RATING

	protected against 0.14 joules impact (equivalent to 0.25kg mass dropped from 56mm above the surface)
	protected against 0.2 joules impact (equivalent to 0.25kg mass dropped from 80mm above the surface)
	protected against 0.35 joules impact (equivalent to 0.25kg mass dropped from 140mm above the surface)
	protected against 0.5 joules impact (equivalent to 0.25kg mass dropped from 200mm above the surface)
	protected against 0.7 joules impact (equivalent to 0.25kg mass dropped from 280mm above the surface)
	protected against 1 joules impact (equivalent to 0.25kg mass dropped from 400mm above the surface)
	protected against 2 joules impact (equivalent to 0.5kg mass dropped from 400mm above the surface)
	protected against 5 joules impact (equivalent to 1.7kg mass dropped from 300mm above the surface)
	protected against 10 joules impact (equivalent to 5.0kg mass dropped from 200mm above the surface)
	protected against 20 joules impact (equivalent to 5.0kg mass dropped from 400mm above the surface)